

SAMHWA

2024

SAMHWA Research & Development
New Products

The logo for SAMHWA, featuring the word "SAMHWA" in a bold, stylized, sans-serif font. The letters are grey and have a modern, geometric feel. The 'S' is particularly large and stylized, with a horizontal bar extending to the left.

Taking its first steps as Samhwa Mold in 1977, SAMHWA Co., has grown into a mold and plastic molding manufacturer, maintaining its dominance in the market for cosmetics subsidiary materials based on its continued investment in R&D, product excellence and customer trust.



Corporate Philosophy

For the past 40 years following our motto, integrity, humility and creativity, SAMHWA has been at the forefront in domestic cosmetic packaging market.

Instead of pursuing a rapid growth, SAMHWA steady and consistently focused in creativeness for innovation with continuous investment in our R&D and was able to promote and introduce GLOBAL MEGA HIT innovative product.

However over the past 40 years, the most significant growth driver was the pursue of our company motto to make wise decisions within fast-changing internal and external environmental factors.

SAMHWA co., Ltd. envision a right path toward the future with new synergies to continuously bring innovative product to our customers.



R&D Philosophy

SAMHWA started business with mold engineering. Over 40 years of capitalized knowhow on mold engineering and technology bring SAMHWA to lead and continuously innovate by developing top leading airless and airtight cosmetic products. Based on our expertise in mold engineering and technology, our R&D is concentrating on developing new innovative product with high quality standard and competitiveness within the cosmetic industry.

Lately, we have focused on developing INNO-ECO Products following the current market trend of favoring eco-friendly products satisfying the 3R aspects (Recycle / Reduce / Reuse). As a result of huge efforts, we were able to successfully develop a new pumping technology and a refill system structure that can combine simplicity and convenience of use. Through the process, we have taken a step closer to our aim to satisfy the customer and as well consumer who use SAMHWA product.

INNO-ECO Products are safe for brands, consumers, and environment. SAMHWA will offer the right quality of products to fulfill the customers' complete satisfaction.



SAMHWA is promptly handling the entire processes with an all-in-house system.

In addition, from cosmetics and daily supplies to medicine and medical supplies, SAMHWA is a comprehensive plastic manufacturer that design, produces and sells plastic-based everyday tools, which make up an irreplaceable part of our lives.

Considering environment and future, SAMHWA is researching & developing BLOW / ECO PUMP / CUSHION products and introducing them under SAMHWA's packaging MAZEL brand.

Index

Product Name		Capacity	Dimension(mm)	Material	Page No.	
CLEANSE & SKINCARE						
Grinding Balm		100g	Ø 82 × 86.5	All PP	14	
Master Blending Series	Airless	25ml + 25ml	Ø 43.6 × 140	All PP	15	
	DP	40ml + 40ml	Ø 48 × 148	PP, PETG	15	
Refill Stick 10g		10g	Ø 27 × 107	All PP	16	
Refill Sunstick 20g		20g	59 × 27 × 85	All PP	17	
Gua Sha Massage Cream	Dial Type - A	65g	66 × 33 × 127	PP, PE, SUS	18	
	Dial Type - B	65g	66 × 33 × 120	PP, TPE, PE, SUS	18	
	Tube Type - A	70ml	56 × 30 × 100	PP, LDPE, SUS	19	
	Tube Type - B	50ml	52 × 26 × 99	PP, TPE, LDPE	19	
Objet Pump		400ml (300, 500ml)	Ø 70 × 173	PP, PET, Eco Pump 2cc	20	
ECO Airless Series		30ml	Ø 36 × 97	PP, LDPE	21	
		50ml	Ø 36 × 122	PP, LDPE	21	
		100ml	Ø 48 × 130	PP, LDPE	21	
TL Focus		50ml	Ø 36 × 125.5	PP, PET, LDPE	22	
DAL Dropper	DAL Dropper	30ml	Ø 37 × 92.5	PP, TPE, PET, GLASS	23	
	DAL Dropper: Flat	30ml	Ø 37 × 94	PP, TPE, PET, GLASS	23	
Refill Glass Airless Series	Refill Glass Airless	15ml	Ø 37.5 × 110	GLASS, PP, Eco Pump 0.2cc	25	
		20ml	Ø 37.5 × 125	GLASS, PP, Eco Pump 0.2cc	25	
		30ml	Ø 37.5 × 150	GLASS, PP, Eco Pump 0.2cc	25	
		50ml	Ø 37.5 × 160	GLASS, PP, Eco Pump 0.2cc	25	
		30ml	Ø 37.5 × 110	GLASS, PP, Eco Pump 0.2cc	26	
	Glass Airless	50ml	Ø 37.5 × 125	GLASS, PP, Eco Pump 0.2cc	26	
		70ml	Ø 37.5 × 150	GLASS, PP, Eco Pump 0.2cc	26	
		90ml	Ø 37.5 × 160	GLASS, PP, Eco Pump 0.2cc	26	
		Refill Square 30ml	30ml	37.5 × 37.5 × 153	GLASS, PP, AL, Eco Pump 0.2cc	26
		AJ50	50ml	Ø 69 × 81.5	GLASS, PP, PETG, Eco Pump 0.8cc	27

Product Name		Capacity	Dimension(mm)	Material	Page No.
BASE MAKEUP					
Ultimate Slim Cushion	Square	15g	75 × 75 × 20.4	All PET(+ PET Based Elastomer)	29
	Circle	15g	Ø 76 × 20.3	All PET(+ PET Based Elastomer)	29
Grind Pact Series	Grinding Compact	15g	Ø 78 × 29.8	Case: ABS / Refill: PP	30
	Grinding Compact: Metal	15g	Ø 78 × 29.8	Case: ABS / Refill: PP + SUS	30
Tension Powder		7-8g	60 × 96 × 26.2	Optional: PET / PETG / PP	31
Clear Deco Powder		10g	Ø 72.8 × 32	PP, SAN	32
Color Corrector	Finger Touch Pen	10ml	Ø 17 × 155.7	PP, LLDPE, PETG, TPE, etc	33
	Rolling Serum: Ball	10ml	Ø 17 × 137	PP, LLDPE, PETG, TPE, etc	33
	Rolling Serum: Silicon	10ml	Ø 17 × 145.5	PP, LLDPE, PETG, TPE, etc	33
	Rolling Serum: Spoid	10ml	Ø 17 × 145.5	PP, LLDPE, PETG, TPE, etc	33
Dip and Fit Spatula		40ml	30 × 30 × 138.5	PP, PET, LDPE, SUS	34
Clear Cushion	BCR	15g	Ø 75 × 24.7	All PET(+ PET Based Elastomer)	35
	DRS	15g	75 × 75 × 24.7	All PET(+ PET Based Elastomer)	35
POINT MAKEUP					
Lipstick Series	Ultimate Slim Lipstick	2g	16 × 16 × 93	PETG, etc	37
	Deep Clear Lipstick	3.5g	20 × 20 × 77	PETG, etc	37
	Slim Lipstick	3.5g	19 × 19 × 75	PETG, etc	37
Multi Care Series	Multi Mascara	8ml + 3ml	Ø 18.6 × 140	PET, PP, ABS, PETG, LDPE	38
	Multi Care Stick	4ml / 8ml + 3ml	Ø 18.6 × 141.7	PET, PP, ABS, PETG, LDPE	38
CN Palette	1 Dish	10g	60 × 60 × 13.5	PETG, AL	39
	3 Dish	2.6g × 2 + 4.2g	60 × 60 × 13.5	PETG, AL	39
	4 Dish	2.3g × 4	60 × 60 × 13.5	PETG, AL	39
BLOW SERIES					
Development					40
Bottle					44
Neck					48
Spray / Spoid / etc.					50

2024 SAMHWA R&D Innovation

SAMHWA keep pushing technical boundaries in each of our new innovative products to combine rapid changing consumer beauty trend needs and sustainable responsibility with the goal to make a step closer in our aim to satisfy our customers and as well consumers who will use SAMHWA innovation.



Cleanse & Skincare

Grind Cream

Large capacity grinding balm for hygienic use.

Grinder
Rotational dial mechanism for ease and hygienic of use



FEATURES

- PP Mono Material
- Antibacterial PP, PCR 100% Applicable
- Airtight Functionality
- ZERO Remaining Capacity
- Soft Rotational Sensitivity
- Easy Filling Process
- Embedded Spatula
- Shower-Proof

CAPACITY

100g

DIMENSION

Ø 82 × 86.5 mm

MATERIAL

All PP

Master Blending Series

The smart blender that adjusts dosage of the formulation to according to the desired effect and use sensibility.

FEATURES

- REDUCE**
Innovative reduction in plastic usage in refill. (19.56% of total weight)
Reduce waste by replacing only minimal parts.
- REFILL**
Innovatively overcome the limitations of recyclability of cosmetic packages.
Easy to separate materials and use.

- Refill-optimized design.
- REUSE**
Maximize resource circulation by repeated reuse of the external package.
Reusing the external package with 3 refills reduces the environmental load by 216%.
- RECYCLE**
Single PP material applied on refill cartridge.

CAPACITY

Airless 25ml + 25ml
DP 40ml + 40ml

DIMENSION

Airless Ø 43.6 × 140 mm
DP Ø 48 × 148 mm

MATERIAL

Airless PP, PETG, LDPE
DP PP, PETG

Label

- Brand identity, formula information. Serves as a handle for convenient refill.
- Easy label removal and recycle. (Green-Value Implementation)



Self Control
Dosage control with a switch dial

Refill Cartridge
Hygienic refill is possible without contamination of the formulation due to the sealed refill package integrated with the dip-tube.

AIRLESS TYPE



DP TYPE

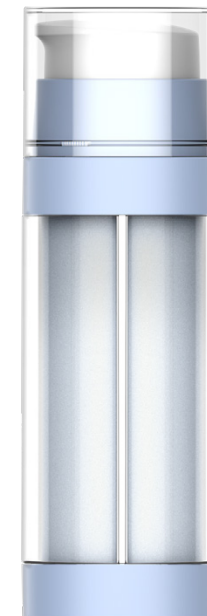

Embedded Spatula



Refill Stick 10g

Simple & easy refill stick with easier gesture for the replacement of the refill.

FEATURES

All PP, Mono material.

Most components are reusable and refill module consists of minimal parts.

Easy slide in refill stick for better user experience for replacing a refill module.

CAPACITY

10g

DIMENSION

Ø 27 × 107 mm

MATERIAL

All PP



Refill Sunstick 20g

Simple & easy refill stick with easier gesture for the replacement of the refill.

Slide In & Out to Replace

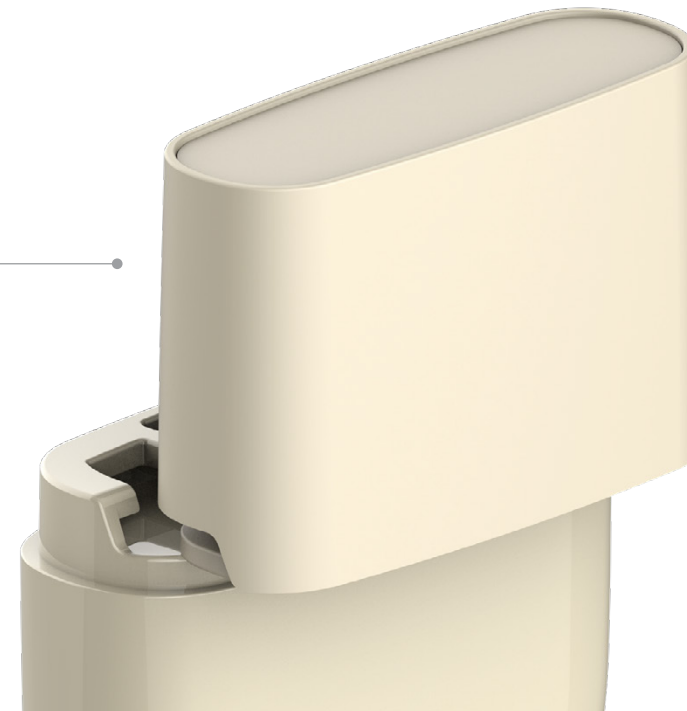

HOW TO REFILL

- 1 Remove refill caps of the refill module.
- 2 Slide in & out to replace.
- 3 Slide in & it clicks.
- 4 Rotate the dial to use.

CAPACITY

20g

DIMENSION

59 × 27 × 85 mm

MATERIAL

All PP

Gua Sha Massage Cream: Dial Type

Easy-use cream with built-in applicator for massage.



FEATURES

Gua Sha applicator package for neck and body.

Dual-Screw

More capacity to be filled with minimal space for structures.

CAPACITY

Type A 65g

Type B 65g

DIMENSION

Type A 66 × 33 × 127 mm

Type B 66 × 33 × 120 mm

MATERIAL

Type A PP, PE, SUS

Type B PP, TPE, PE, SUS

Gua Sha Massage Cream: Tube Type

Easy-use cream with built-in applicator for massage.



Type A + Heart Gua Sha Applicator



Type B + Protruding Gua Sha Applicator



Type A + Heart Gua Sha Applicator



Type B + Protruding Gua Sha Applicator

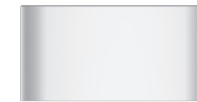

FEATURES

Gua Sha applicator package for neck and body.

Refill & Choice

It can be used by selecting easy refills and various applicators as a screw fastening applicator.

CAPACITY

Type A 70ml

Type B 50ml

DIMENSION

Type A 56 × 30 × 100 mm

Type B 52 × 26 × 99 mm

MATERIAL

Type A PP, LDPE, SUS

Type B PP, TPE, LDPE

Objet Pump

A pump with a sensuous design that will become an objet in everyday life.

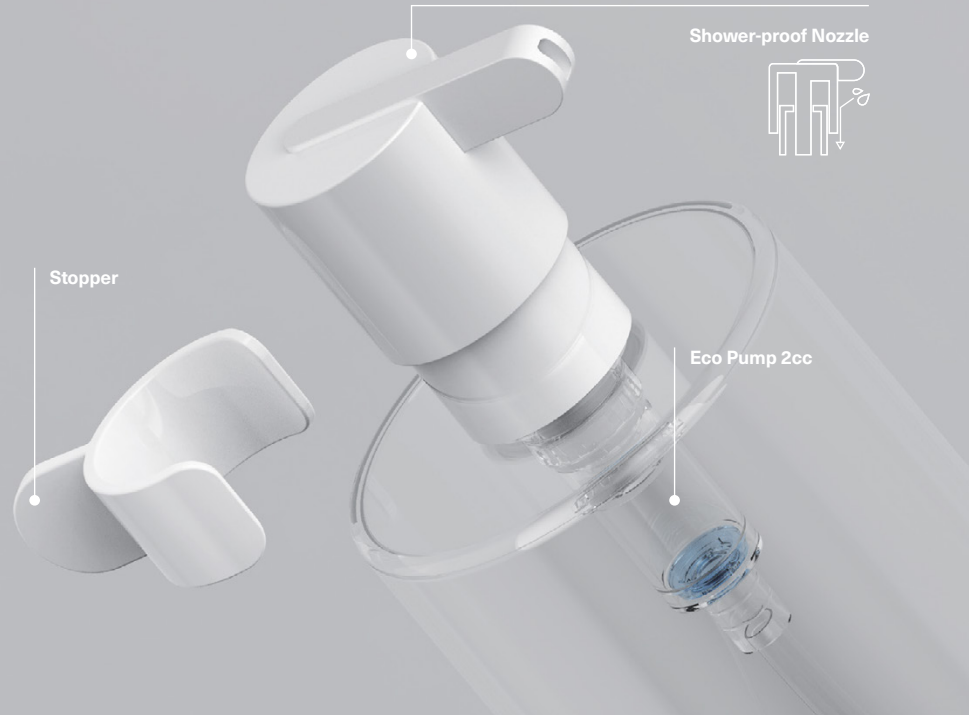

FEATURES

Interior Objet Design

Shower Proof Nozzle

Unlike conventional pump structures in which water enters through between the shoulder and the nozzle when shower, the nozzle covers the shoulder to prevent water from entering the package.

Eco Pump

Easy to recycle by using the ALL PP Eco pump with the metal spring removed.

CAPACITY

300ml, 400ml, 500ml

DIMENSION

400ml Ø 70 × 173 mm

MATERIAL

PP, PET, Eco Pump 2cc

ECO Airless

The single material(above 90%) Eco-package for Clean Beauty.



FEATURES

All PP Material

Easy to Recycle

PCR Applicable

Various Capacity Options

CAPACITY

30ml, 50ml, 100ml

DIMENSION

30ml	Ø 36 × 97	mm
50ml	Ø 36 × 122	mm
100ml	Ø 36 × 130	mm

MATERIAL

PP, LDPE

TL Focus

A new concept package with simplified internal parts to highlight the formulation.

FEATURES

Discharge Without Tube or Piston

The dip tube-free structure allows the formulation to be discharged through the internal flow path when pumping.

Formula Focus

The design with no interior structure in center emphasizes special solid substances such as herbs, petals, and gold pearls can be inserted into a center of the formula space to maximize the functions of cosmetics.

Formula Flow Focus

Through post-processing (graphics) that shows only the flow path or the shape of the brand logo, the formulations can be emphasized by showing the effect of filling the graphics when used for the first time.

CAPACITY

50ml

DIMENSION

Ø 36 × 125.5 mm

MATERIAL

PP, PET, LDPE



DAL Dropper

Dropper with a design reminiscent of the clear full moon.

FEATURES

Differentiated from the current pre-mold market.

Bi-injection technology applied.

Reduced number of parts.

Olefin single material.

Trendy design.

Comfortable grip.

CAPACITY

30ml

DIMENSION

Sphere Ø 37 × 92.5 mm

Flat Ø 37 × 94 mm

MATERIAL

Outer Cap PP

Spoid Rubber TPE

Inner Cap PP

Inplug PE

Spoid GLASS / PP

Bottle PET



Refill Glass Airless Series

Luxe Packages with maximum Eco-friendliness.

FEATURES

Upgradable aesthetic by adding various visual effects processes to reusable glass package.

Reusing the external package with 3 refills reduces the environmental load by 248%.

Refill cartridge: ALL PP

PRODUCT LIST

Refill Glass Airless	15ml
	20ml
	30ml
	50ml
Glass Airless	30ml
	50ml
	70ml
	90ml
Square	30ml
AJ50	50ml



REFILL GLASS AIRLESS SERIES

Refill Glass Airless

FEATURES

REUSE: Glass Bottle

Reusable Glass Bottles are able to decorated express luxury with eco-friendliness.

RECYCLE: Refill Module

The refill module that is thrown away after use is composed of ALL PP Mono material to increase recyclability.

Zero residual capacity by Implementation of piston and inner structure.

REDUCE: Eco Pump

Remove the metal spring that hinders recycling and implement. It close to a Mono material using PP-based TPE.

REUSE: Shoulder & Cap

Reusable Shoulder & Cap are able to decorated express luxury with eco-friendliness.

HOW-TO REFILL & USE

- 1 Pull out the pump to remove the module.
- 2 Remove the refill cap.
- 3 Put the pump module part in a new refill bottle.

CAPACITY

15ml, 20ml, 30ml, 50ml

DIMENSION

15ml	Ø 37.5 × 110	mm
20ml	Ø 37.5 × 125	mm
30ml	Ø 37.5 × 150	mm
50ml	Ø 37.5 × 160	mm

MATERIAL

GLASS, PP, Eco Pump 0.2cc

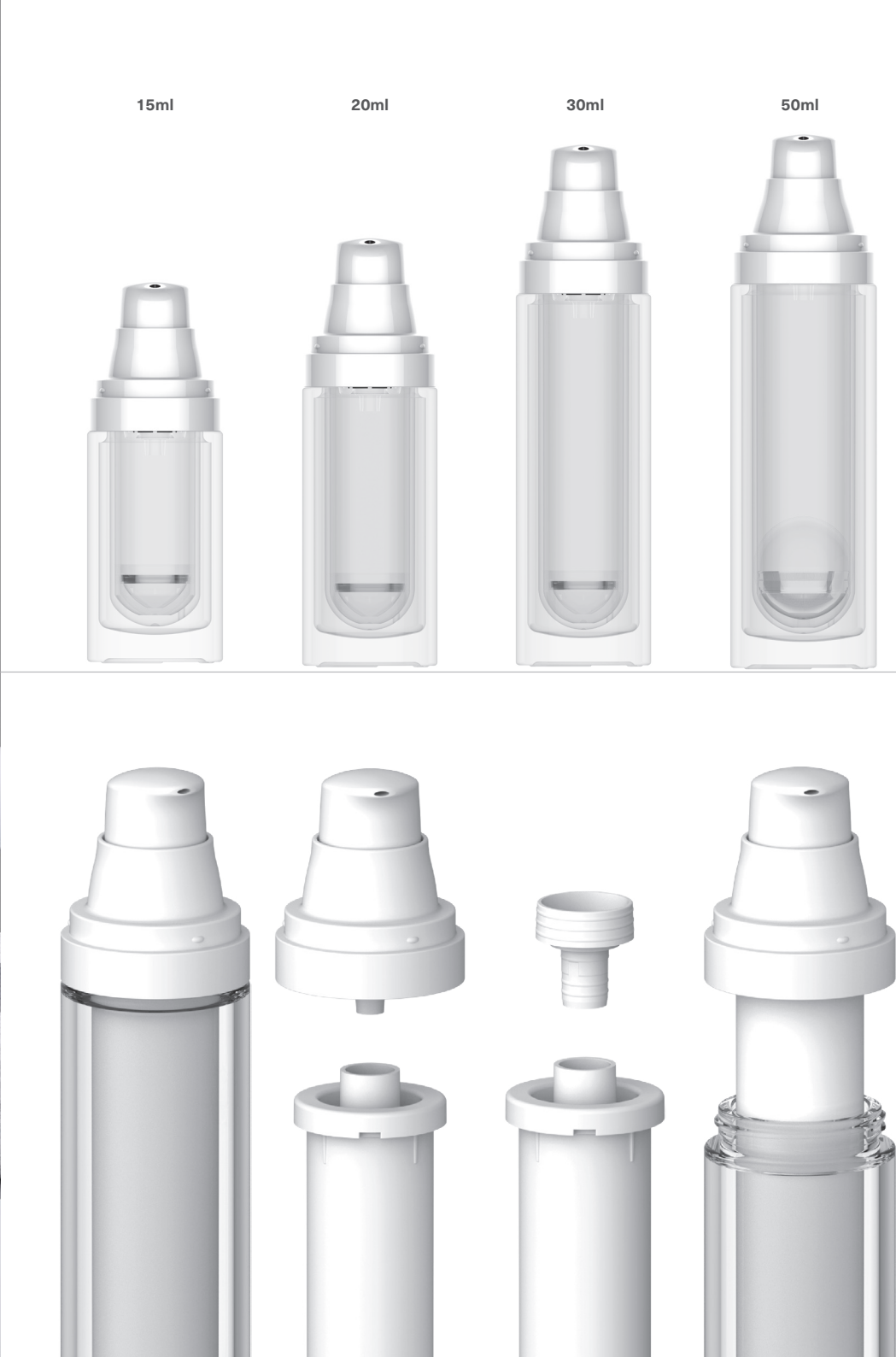

REFILL GLASS AIRLESS SERIES

Non Refill Type

CAPACITY

30ml, 50ml, 70ml, 90ml

DIMENSION

30ml	Ø 37.5 × 110	mm
50ml	Ø 37.5 × 125	mm
70ml	Ø 37.5 × 150	mm
90ml	Ø 37.5 × 160	mm

MATERIAL

GLASS, PP, Eco Pump 0.2cc

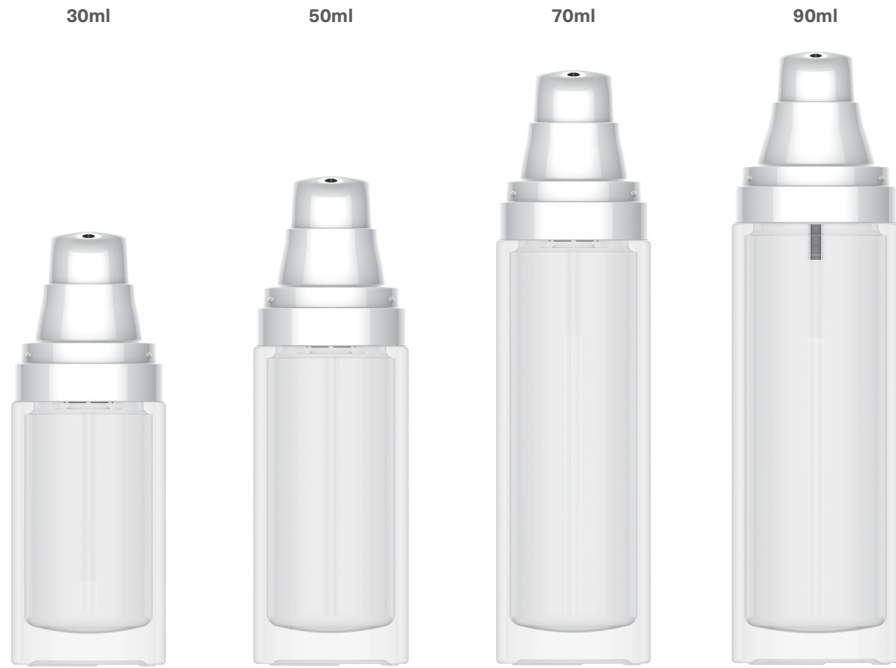

REFILL GLASS AIRLESS SERIES

Square 30ml

CAPACITY

30ml

DIMENSION

37.5 × 37.5 × 153 mm

MATERIAL

GLASS, PP, AL, Eco Pump 0.2cc



REFILL GLASS AIRLESS SERIES

AJ50

FEATURES

Anti-Bacterial Material(Optional)

Sealed Structure

Easy Refill System

Minimal Residues System

0.8cc Eco Pump

Easy Refill System

CAPACITY

50ml

DIMENSION

Ø 69 × 81.5 mm

MATERIAL

Overcap PETG

Nozzle PP

Shoulder PETG

Eco Pump 0.8cc PP + TPE

Overcap PP

Piston PE

Inner Bottle PP

Outer Bottle GLASS



Base Makeup



Square

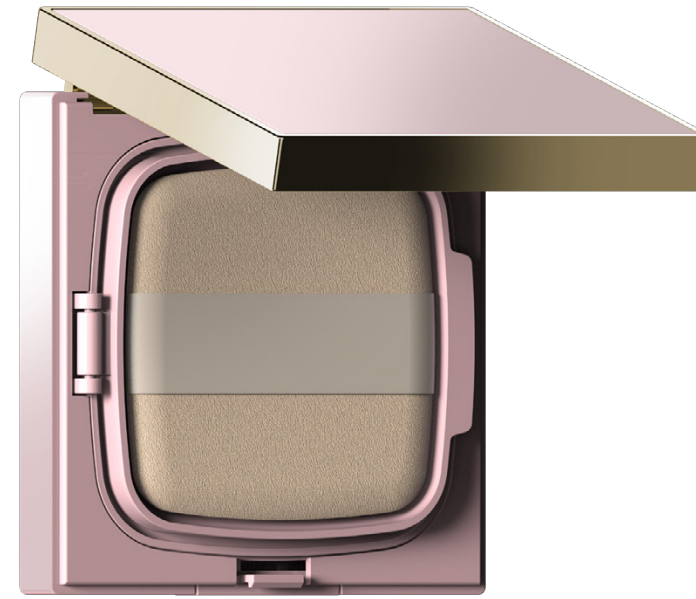

Circle



Base Makeup

Ultimate Slim Cushion

Ultimate Slim Cushion is a full-featured product, with airtightness, refills, full size puff, large mirror, and 15g of formula.

FEATURES

Larger Mirror

Airtight

Bi-injected refill cover for maximum airtightness.

Better Usability

Larger area, compared to other circular refills, provides better usability.

Larger Puff

CAPACITY

15g

DIMENSION

Square 75 × 75 × 20.4 mm

Circle Ø 76 × 20.3 mm

MATERIAL

All PET(+ PET Based Elastomer)

Grinding Compact

Grinding compact that gives you a fresh feeling of use when it touches your skin.

FEATURES

PP Mono material

Antibacterial PP, PCR 100% applicable

Airtight functionality

Zero remaining capacity

Soft rotational sensitivity

Easy filling process

Refillable cartridge module

Hygienic Use

No exposure of the formulation when use unlike sponge or meshed cushion or balm type packages, it can be used hygienically by turning the dial cutter and discharging the formulation as much as needed to reduce unnecessary contact with the puff or applicator.

CAPACITY

15g

DIMENSION

Ø 78 × 29.8 mm

MATERIAL

PP Version Outer case: ABS
Refill Module: PP

Metal Version Outer case: ABS
Refill Module: PP + SUS

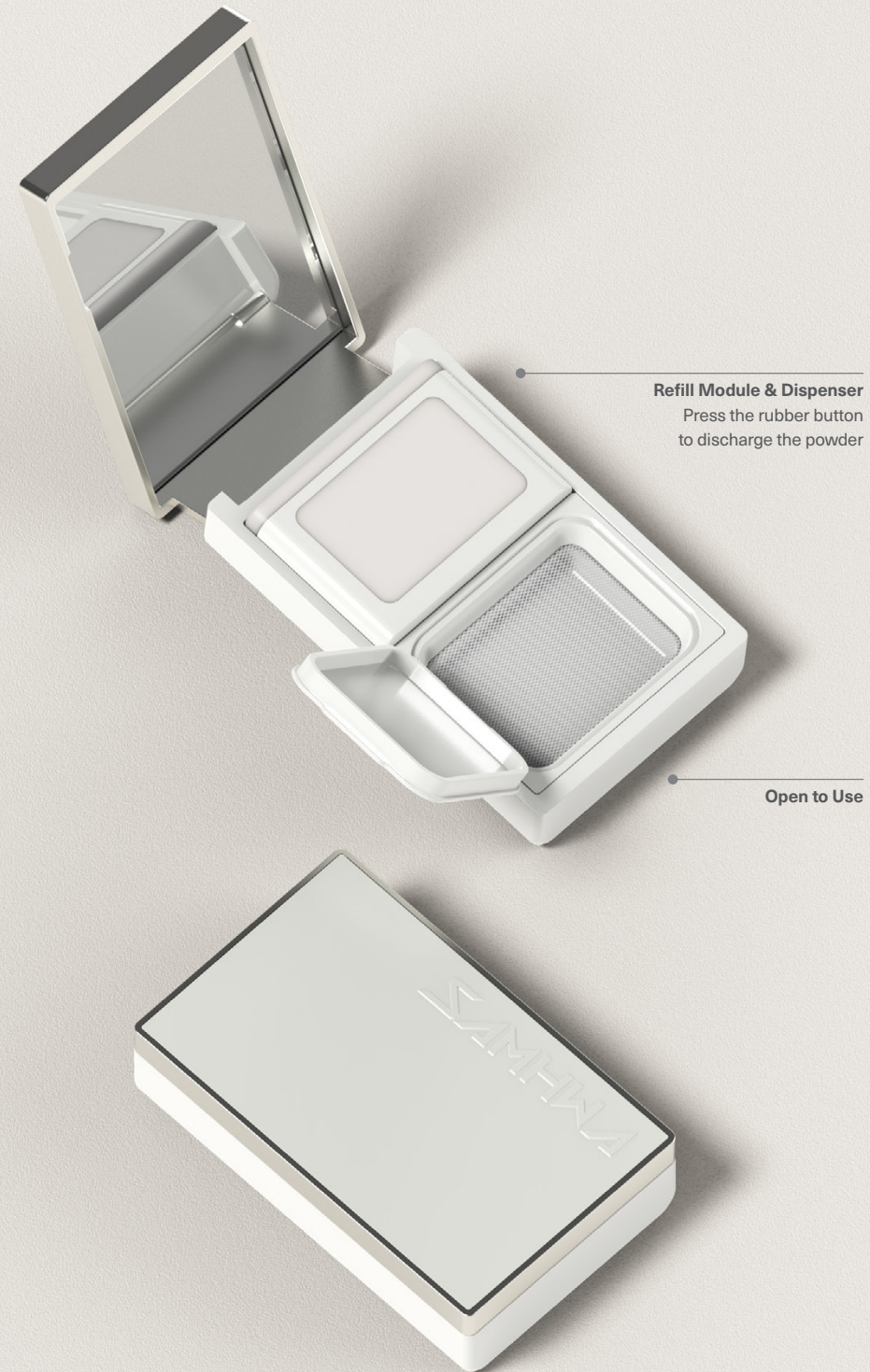
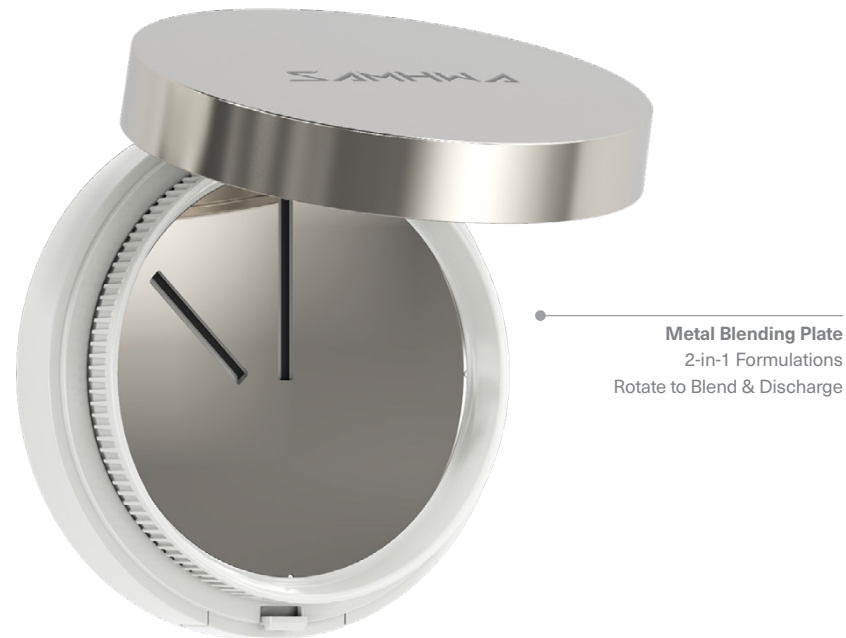
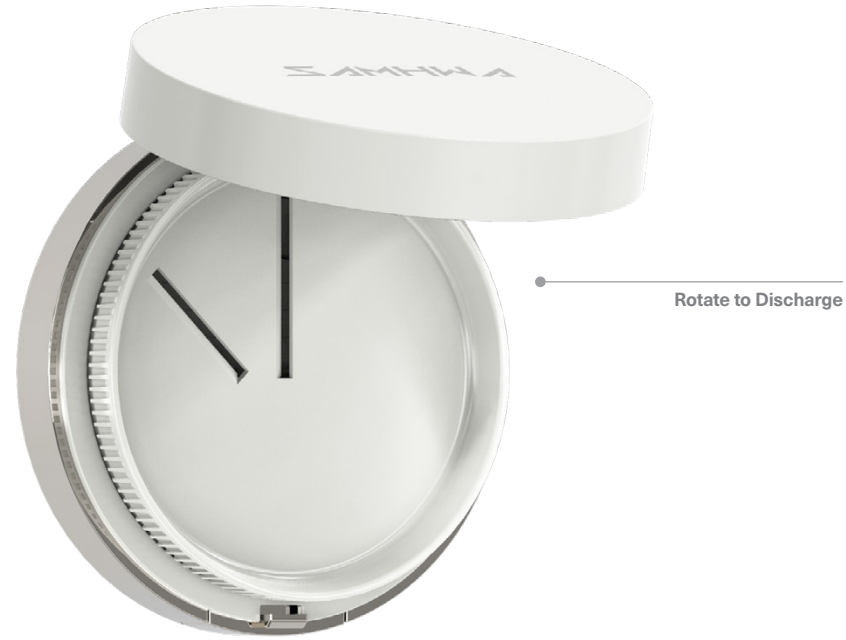

Tension Powder

A new concept powder compact that delivers the foundation to the applicator without fluttering.

HOW TO REFILL & USE

- 1 When refilling, engage the refill module as in the conventional cushion refill process.
- 2 Press the rubber button to discharge the powder in cartridge.
- 3 Open the inner top case and use powder under the mesh.

CAPACITY

7-8g

DIMENSION

60 × 96 × 26.2 mm

MATERIAL

PET / PETG / PP (Optional)

Clear Deco Powder

Transparent deco-powder with various custom design applicability.



CAPACITY

10g

DIMENSION

Ø 72.8 × 32 mm

MATERIAL

PP, SAN

Color Corrector

Clean & easy applicators that touches various areas such as eyes, mouth and more.

Finger Touch Pen

Ball

Spoid

Silicon



FEATURES

Ergonomic button design for spot area treatment.

Fingertip-like wide and flexible applicator replaces use of finger.

Pen type body for easy to hold and accurate use.

Airless system

CAPACITY

10ml

DIMENSION

Finger Touch Pen Ø 17 × 155.7 mm

Ball Ø 17 × 137 mm

Silicone Ø 17 × 145.5 mm

Spoid Ø 17 × 145.5 mm

MATERIAL

PP, LLDPE, PETG, TPE, etc

Dip and Fit Spatula

Easy dip & delicate fit to complet base makeup, all-in-one spatula foundation.



CAPACITY

40ml

DIMENSION

30 × 30 × 138.5 mm

MATERIAL

Cap	PP
Spatula	SUS
Wiper	PE
Bottle	PET



Clear Cushion

The most clear cushion compact with minimal structure and mono material.



CAPACITY

15g

DIMENSION

BCR Cushion	Ø 75 × 24.7	mm
DRS Cushion	75 × 75 × 24.7	mm

MATERIAL

All PET(+ PET based elastomer)

Point Makeup



Point Makeup

Lipstick Series

Deep Clear Lipstick

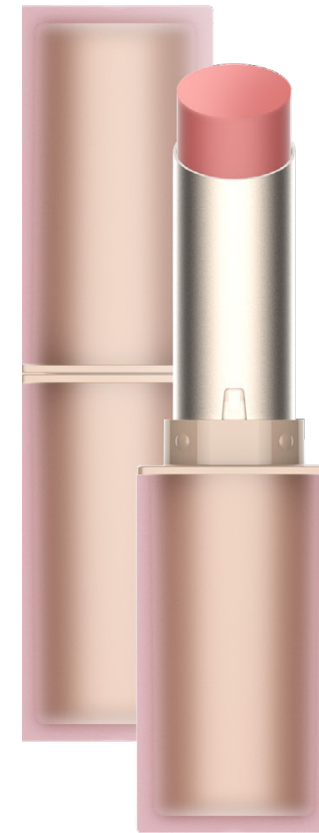

Ultimate Slim Lipstick

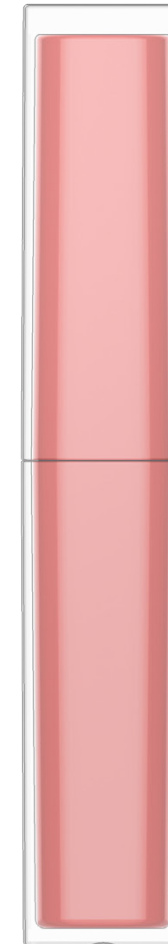

Slim Lipstick

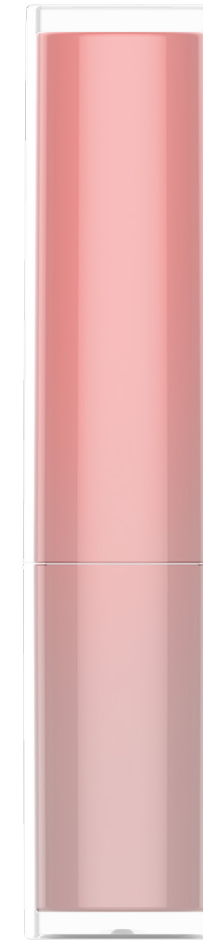

The slim lipstick series with bi-injection for various expressions and depths.

CAPACITY

Deep Clear Lipstick 3.5g

Ultimate Slim Lipstick 2g

Slim Lipstick 3.5g

DIMENSION

Deep Clear Lipstick 20 × 20 × 77 mm

Ultimate Slim Lipstick 16 × 16 × 93 mm

Slim Lipstick 19 × 19 × 93 mm

MATERIAL

PETG, etc

mazel

MULTI CARE SERIES

Multi Mascara

2-in-1 multi mascara packages for makeup and lash care in a single step.

CAPACITY

Essence Bottle	3ml
Outer Bottle	8ml

DIMENSION

Ø 18.6 × 140	mm
--------------	----

MATERIAL

PET, PP, ABS, PETG, LDPE

Ease of use with a button

An appropriate amount of nutritional essence discharged to the inside as the button is pressed.

Hygienic Mixing

Hygiene without concern of contamination due to no exposure of the secondary formulation to the air.



Long Lasting Freshness

Freshness of the air-blocked formulation that is transmitted to the skin as you apply it.

Concentration Control

The secondary formulation helps control the concentration of the primary formulation to complete a smooth feeling of use.

No more inconvenience

Both eye makeup and lash care can be performed at once without using two products separately.

MULTI CARE SERIES

Multi Care Stick

2-in-1 multi care stick for both makeup and skincare in a single step.

CAPACITY

Formula 1	4ml / 8ml
Formula 2	3ml

DIMENSION

Ø 18.6 × 141.7	mm
----------------	----

MATERIAL

PET, PP, ABS, PETG, LDPE

Ease of use with a button

Press the button to discharge the secondary formulation and rotate the button to lock when not in use to prevent the formulations from accidentally mixing into each other.



Formula 1

Formula 2

CN Palette

A complete transparent palette with deep transparency and a variety of color options.



1 Dish

4 Dish

3 Dish

CAPACITY

1 Dish	10g
3 Dish	2.6g × 2 + 4.2g
4 Dish	2.3g × 4

DIMENSION

60 × 60 × 13.5	mm
----------------	----

MATERIAL

PETG, AL



Blow Development

SAMHWA co., Ltd. has been leading the global skincare market with airless and dispensing pump product, as well as the global makeup market with the World's Best airtight compact.

With continuous investment in business expansion, in 2018, SAMHWA expanded it's operation to enter the household product market by building a blow facilities.

With over 40 years of experience and technology knowhow, SAMHWA will bring the innovative blow product to the cosmetic market as well as the household market.

Heavy Blow Method Container Made

Based on our mold knowhow, we are planning and developing a wide range of product.
We are also developing products in collaboration with domestic and foreign customers.

Core Technology
Lighter than glass, unbreakable, and has the same effect as glass(increased price competitiveness)
Various designs and post-processing available

Blow injection machine line

Auto label application process

Finished blow bottle line output

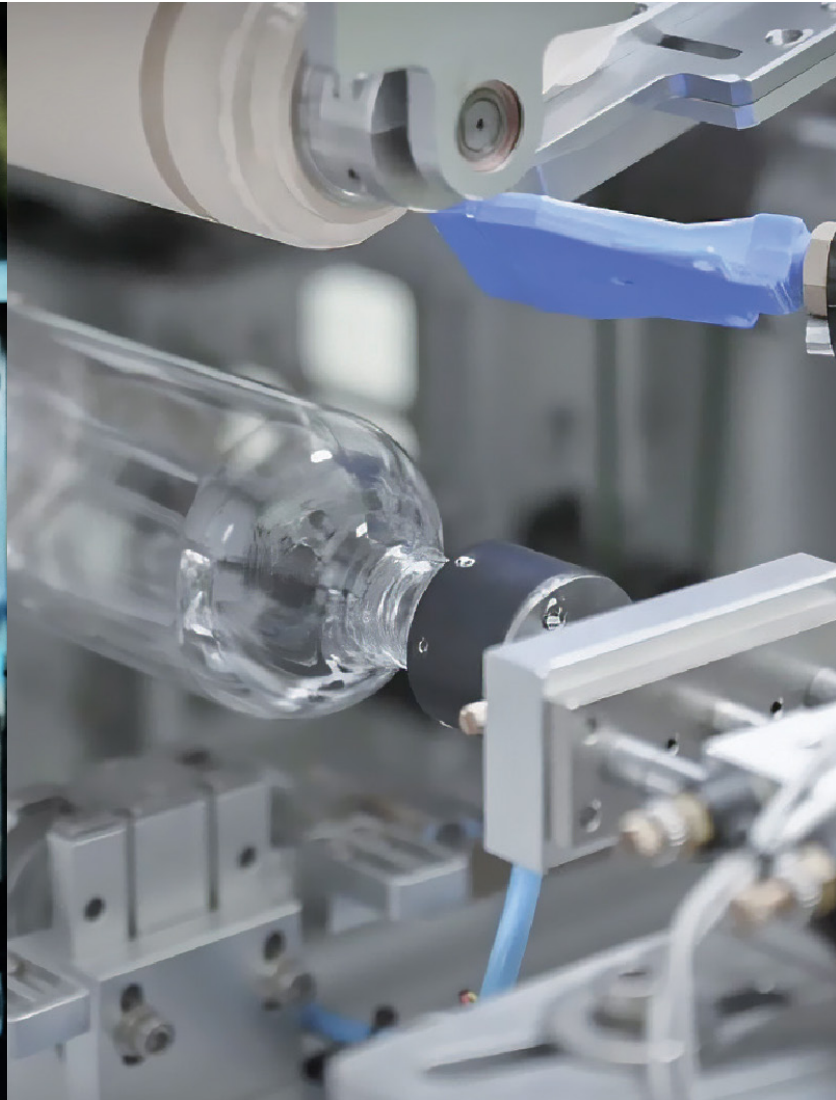

Blow Bottle

6.5ml

30ml

35ml

40ml

43ml

50ml

60ml

80ml

100ml



Slim Shaker
Ø 17



Hidden
Ø 18



HSL
Ø 20



Smart Dropper
Ø 18



Classic Circle
Ø 20



Hexa_GPC
Ø 18



Boston
Ø 18



Hidden
Ø 18



PL_DP
Ø 17



Jar Circle
Ø 55



Hidden
Ø 18



Classic Square
Ø 20



Boston
Ø 18



Classic Circle
Ø 20



TR
Ø 20



Ringer
Ø 18



CV
Ø 18



Hidden
Ø 18



Hidden CO18
Ø 18



GL Pact
Ø 66



HSL
Ø 20



R3
Ø 20



CRX
Ø 24



Mist Circle
Ø 20



Mist Circle
Ø 20



Boston
Ø 18



R5
Ø 20



Jar Square
Ø 57



Classic Circle
Ø 20



Classic Square
Ø 20



Mist Circle
Ø 20

Blow Bottle

120ml 125ml 130ml 140ml 150ml 200ml



KM
Ø 20



MR
Ø 24



PL_DP
Ø 17



Hexa_GPC
Ø 18



Ringer
Ø 18



Classic Circle
Ø 20



Classic Square
Ø 20



CRX
Ø 24



Classic Circle
Ø 20



Classic Square
Ø 20



Jar Circle
Ø 55



Hidden
Ø 18



Classic Square
Ø 20



Circular Angle
Ø 24



Boston
Ø 18



CRX
Ø 24

280ml 300ml 400ml 500ml



CRX
Ø 24



MM
Ø 24



DMI
Ø 24



Circular Angle
Ø 24



DMI_Snap-on
Ø 24



Boston
Ø 18



Classic Circle_Screw
Ø 24



Boston_Snap-on
Ø 24



CRX
Ø 24



Classic Circle_Snap-on
Ø 24



Boston_Screw
Ø 24



Circular Angle
Ø 24



Circular Angle
Ø 24

Blow Neck

Ø 18



PUMPS5007 PUMPS5010 CAPPS1021 CAPPS1022 CAPPS1024 PUMPS5008

Ø 20



PUMPS5011 PUMPS5009 CAPPS1001 CAPPS1002 PUMPS5015 PUMPS5016



PUMPS5017 PUMPS5018 PUMPS5019 PUMPS5020

Ø 24



CAPPS1003 CAPPS1004 CAPPS1005 CAPPS1020 PUMPS5001 PUMPS5002

Ø 24



PUMPS5006

Ø 39



CAPPS1014

Ø 39.8



CAPPS1017

Ø 44



CAPPS1006



CAPPS1016

Ø 45



CAPPS1015

Blow
Spray

Spoid

etc.

ECN

Ø 18

SLIM CAP



40° (PUMPS5014 + CAPPS1012)
60° (PUMPS5096 + CAPPS1012)

CAPPS1028

CAPPS1026

BULLY

Ø 20

STANDARD CAP



40° (PUMPS5014 + CAPPS1023)
60° (PUMPS5096 + CAPPS1023)

CAPPS1029

CAPPS1027

VALT

SHAKER CAP



40° (PUMPS5014 + CAPPS1011)
60° (PUMPS5096 + CAPPS1011)

CAPPS1025



SAMHWA



Website samhwakorea.com
Instagram [@samhwa_packaging](https://www.instagram.com/samhwa_packaging)
Address 16071
14 Ojedonggeop-gil, Uiwang-si, Gyeonggi-do, Samhwa